

Shaft Shown in Full
C.C.W. Position

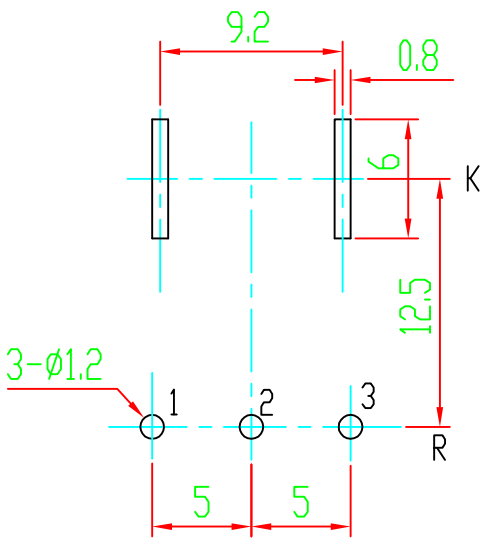
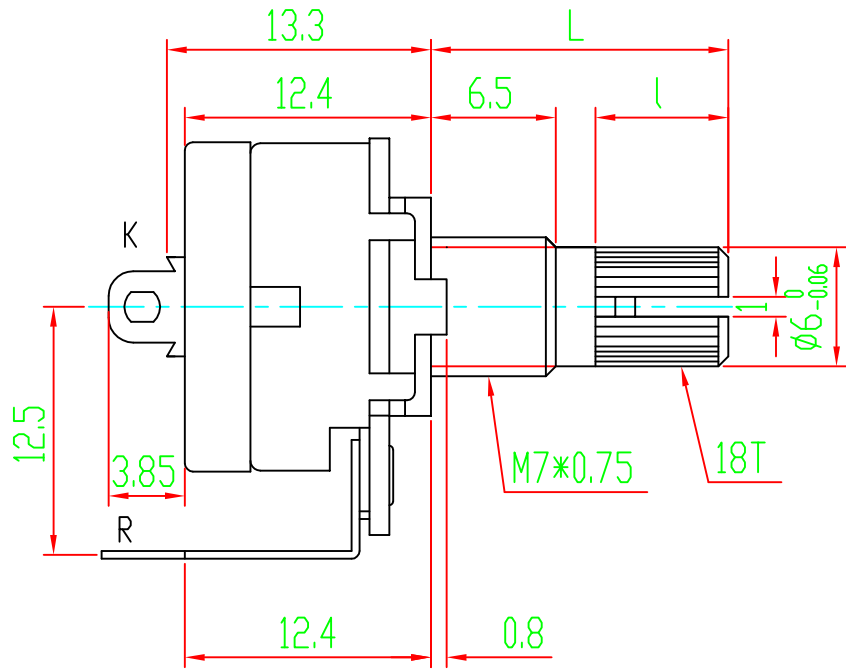
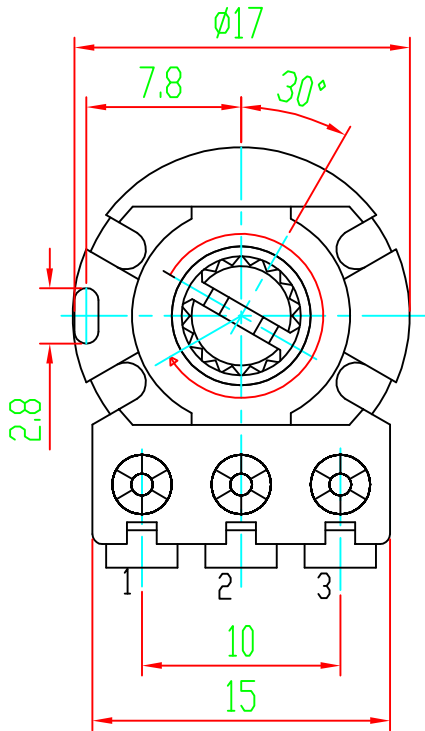

P.C.B MOUNTING DETAIL

L	15	20	25	30
l	7	12	12	12

02				05			
01				04			
	DATE	REVISION	APPROVED	03			

MODEL: WH148K2-4 L15 18T

DRAWING NO:



常州宇豪电子有限公司

CHANGZHOU YUHAO ELECTRONIC CO.,LTD.

DRAW	CHKD	APPD
------	------	------