

Shaft shown in full
C.C.W. position

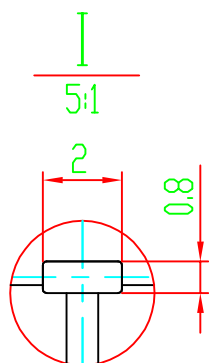

P.C.B MOUNTING DETAIL

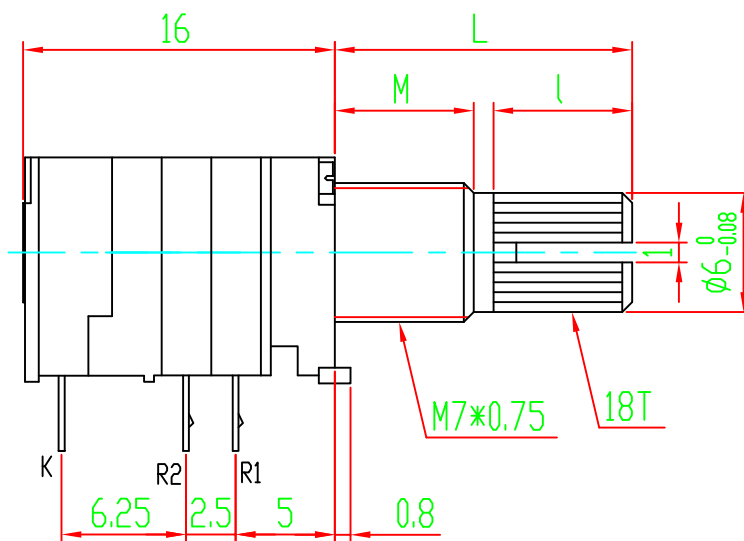
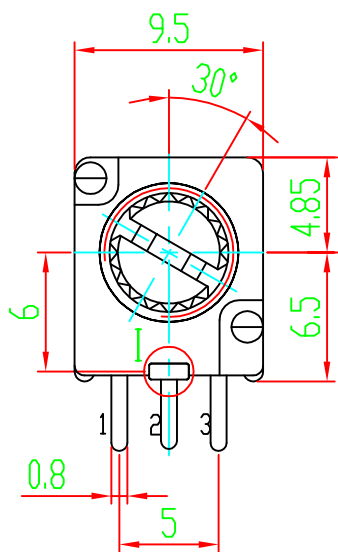
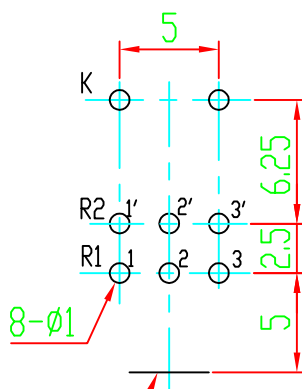

Mounting Surface

M	5
	7

L	15	20	25	
l	7	12	12	

02				05		
01				04		
	DATE	REVISION	APPROVED	03		

MODEL: WH9011AK-2 L15 18T

DRAWING NO:



常州宇豪电子有限公司

CHANGZHOU YUHAO ELECTRONIC CO.,LTD.

DRAW	CHKD	APPD
------	------	------